





Lectra/San[®] EC

Installation and Maintenance Instructions

THE FOLLOWING ARE CAUTIONARY STATEMENTS THAT MUST BE READ AND FOLLOWED DURING BOTH INSTALLATION AND OPERATION

WARNING:  *Raritan Engineering Company, Inc. recommends that a qualified person or electrician install this product. Equipment damage, injury to personnel or death could result from improper installation. Raritan Engineering Company, Inc. accepts no responsibility or liability for damage to equipment, or injury or death to personnel that may result from improper installation or operation of this product.*

WARNING:   **HAZARD OF SHOCK AND FIRE** - Always use recommended fuse/circuit breaker and wire size.

WARNING:  **HAZARD OF FLOODING** - Always shut off seacocks before leaving boat unattended. Double clamp all hose fittings below the waterline, check hose clamps frequently for integrity.

WARNING:  *The Lectra/San EC operates on an Electrochemical principle. Introduction of any substance other than salt water, human waste or toilet tissue may cause heat build up and extensive damage. If any other substance is introduced by accident, the Lectra/San EC must not be turned on until entire system is flushed out with water.*

INTRODUCTION

The Lectra/San EC is a U.S. Coast Guard Certified Type I Marine Sanitation Device for uninspected vessels less than 65 feet in length. Lectra/San EC accommodates most marine toilets. It can be used with one or two toilets (see page 10). It is designed and approved to treat waste for overboard discharge in areas that are not declared a No-Discharge zone by the U.S. Environmental Protection Agency. The total system is made up of three basic parts:

The Control Indicator Panel - Begins the treatment cycle and can also be connected to flush an electric toilet at the same time (single toilet application).

Dimensions: 4 1/2"H x 2 3/4"W x 1"D

The Treatment Tank - Consists of two chambers and an electrode pack that temporarily converts

salt water into a powerful bactericide for the duration of the treatment cycle. The top of the tank contains the control module and its protective cover. Dimensions: 16"W x 8 3/4"D x 13 1/2"H

Salt Feed Tank - Necessary to supply a saturated salt solution when not operating in water of ocean salinity. Dimensions: 9"W x 9"D x 7"H

Additional parts included: 1 1/2" hose adapters (2), 1 1/2" NPT Intake Plug, 90° 1 1/2" slip PVC fitting, ribbon cable, salt tank attachments, Owners manual, warranty information, template for Operation Instruction Wall Placard Indicator Panel and U.S.C.G. Type I Equipped label.

NOTE: To comply with U.S.C.G. Regulations, the instruction wall placard should be placed near the control indicator panel and the "U.S.C.G. Type I Equipped" label MUST be in a visible location.

OPERATION

Press yellow button (Push to Flush) to activate Lectra/San EC system.

NOTE: Toilet must not exceed 1.5 gallons of waste water during any total flush cycle.

1. If your toilet is electrically connected with the Lectra/San EC (see Figs. 9 and 9A), it will flush automatically. You may flush the toilet as necessary at 10 second intervals within the first 40 seconds (duration of the FLUSH cycle).



DO NOT FLUSH TOILET AFTER THE FLUSH CYCLE LIGHT GOES OFF.

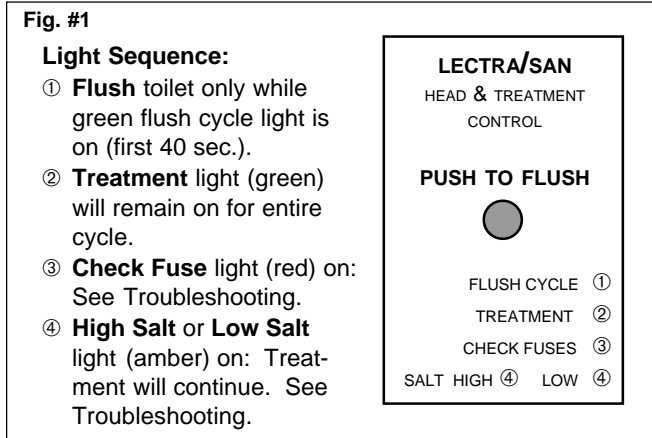

2. If using a manual toilet or electric toilet installed on a separate circuit, **Lectra/San EC must be activated before flushing the toilet.**

TREATMENT CYCLE

(How it Works and What it Does)

The flushing action of the marine toilet discharges waste and water into the first chamber of the Treatment Unit. There, waste is macerated and treated. Proprietary electrode plates are electrically energized to temporarily convert salt water into a strong bactericide, hypochlorous acid. This solution treats the waste by eliminating bacteria and viruses, then it reverts back to the original state of salt and water.

Upon the next flush of the toilet, additional waste enters the first chamber, forcing some of its treated contents into the second chamber. While the new waste is being macerated and treated in the first chamber, the contents of the second chamber are stirred and given additional treatment. A mixer is located in the second chamber to prevent sludge from accumulating and to ensure uniform treatment of its contents.

Successive flushes move the original toilet discharge through the Lectra/San EC and eventually overboard. **When the discharge enters the water it is completely treated and no harmful elements are added to the environment.**

MAINTENANCE

IMPORTANT: Cleaning and Winterization instructions are based on having an electric toilet connected to the Lectra/San EC for single button operation.

Periodically inspect the unit for leaks and check for loose plumbing and electrical connections.

WARNING: If the toilet is wired on its own circuit, or manually operated, make sure power to Lectra/San EC is OFF prior to cleaning and/or winterizing.

CLEANING

WARNING: DO NOT activate the Lectra/San EC during this procedure. Discharge seacocks must be in OPEN position.

NOTE: The following procedures pertain to use with single button operation toilets.

Completely read all instructions before beginning the procedure.

Treatment Tank:

1. Remove the three fuses from the Control Module (located on the top of the Treatment Tank). **Mark each fuse for replacement purposes.** Fuse removal will permit operation of an electric toilet without activating the Lectra/San EC.
2. Shut off intake seacock to the toilet, if necessary. Once fuses have been disconnected, flush bowl as dry as possible.

WARNING: Before using acid, observe safe handling instructions on container.

3. Add one pint of muriatic acid, 31% by weight (available from hardware stores), to a two gallon plastic bucket of fresh water.
4. Pour the solution into the toilet and flush the toilet (press button) as dry as possible so the solution is forced into the treatment unit.
5. Pour an additional gallon of fresh water into the toilet bowl to dilute the remaining acid. Let stand for 45 minutes before flushing toilet.
6. Open intake seacock or water supply. Flush the toilet as often as possible during the flush cycle. (During the Treatment Cycle the toilet cannot be flushed.) Allow the Treatment Cycle to finish. Repeat four times.
- 6a. For toilets which are not controlled by the Lectra/San control open intake seacock and water supply. Flush the toilet at least 15 times for 15 seconds each time (minimum of 10 gallons rinse water) to effectively dilute and discharge the Lectra/San EC contents.

7. Reinstall all three fuses in proper sequence, per Fig. #10 and specifications table.

Salt Feed Tank:

1. Thoroughly rinse and wipe out tank.
2. Check to make sure the small vent hole in tank cap is not blocked.
3. Rinse out connection hose with fresh water.
4. Clean T/Check Valve assembly.

STORAGE

Short Term Storage

NOTE: Failure to perform the following may result in an odor problem and contribute to mineral buildup in the system.

If the boat's toilets are not going to be used for up to one week, activate the treatment unit and flush the toilet(s) twice for the complete flush cycle before leaving the boat.

Long Term Storage

If the boat's toilets are not going to be used for over a week, follow short term storage instructions and also purge the toilet hoses and Lectra/San EC with fresh water.

See Recommissioning and Start up.

WINTERIZATION

WARNING: DO NOT USE ANTIFREEZE IN LECTRA/SAN EC.

1. Run Treatment Cycle five times, flushing the toilet for the entire duration of the 40 second flush cycle.
2. Close seacocks.
3. Disconnect and drain hoses.
4. Using a pump, remove water from the Treatment Unit (through crossover cap).
5. The electrode pack should be inspected and cleaned. Remove the Treatment Unit Cover and pull out the electrode pack. Rinse with fresh water and clean with a stiff **non-wire** brush. Empty any remaining water from the tank.

RECOMMISSIONING & START UP

1. Reconnect hoses and open seacocks.
2. Remove the three fuses from the Control Module (located on the top of the Treatment Tank). **Mark**

each fuse for replacement purposes. This will allow operation of an electric toilet without activating the Lectra/San EC.

3. Flush the toilet four times, allowing approximately two gallons of salt water to enter the Treatment Tank.
4. Reinstall the three fuses in proper sequence, per Fig. #10.

INSTALLATION

Use Figures #2 through #4 which show some installation options. (Drawing are not to scale.)

WARNING: Below waterline installations must include a vented loop. The top of the loop must be

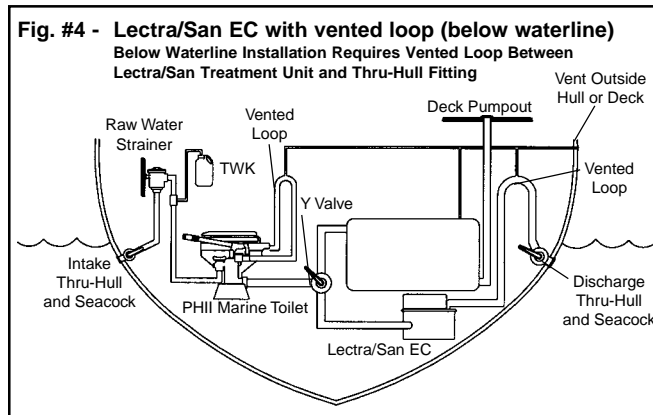
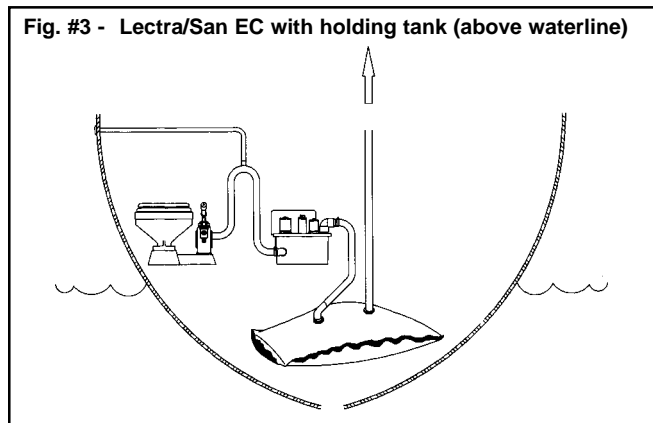
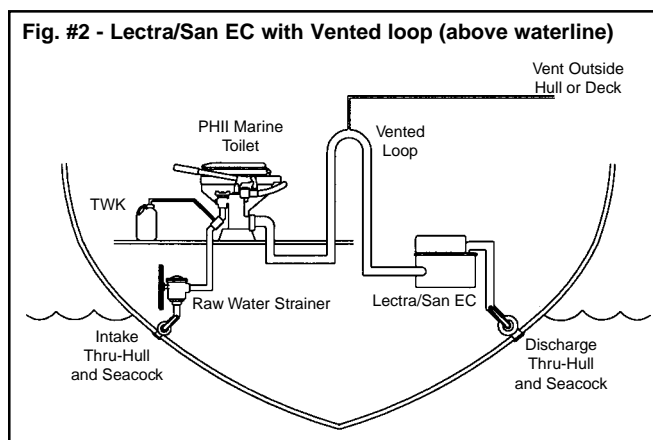

PLUMBING

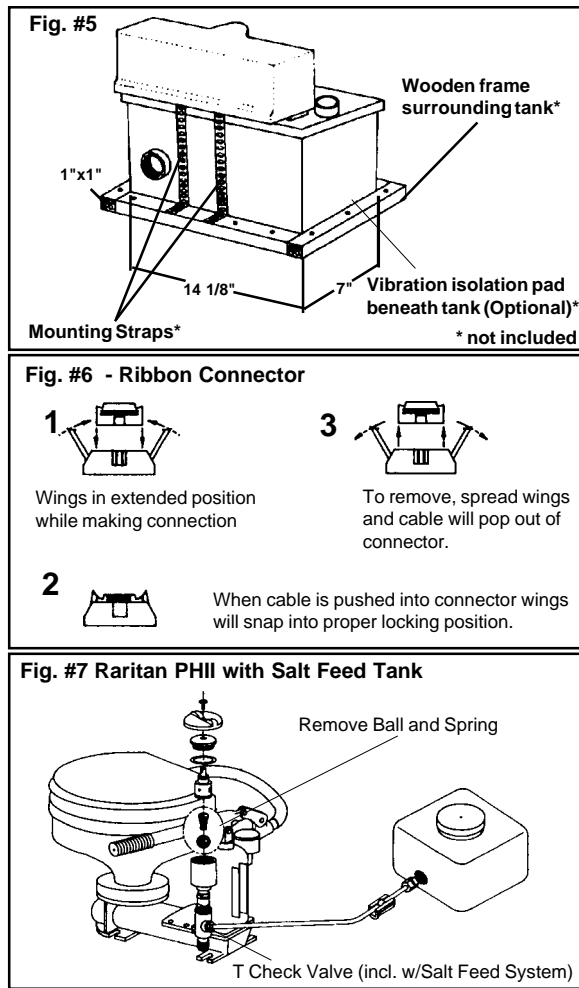

above the waterline at maximum heel to prevent siphoning.

MOUNTING

Treatment Unit

Location: The Treatment Tank should be within six feet of the toilet, with the tank located at the same level or lower than the toilet's discharge. If the tank is at the same level, or slightly above the toilet, a vented loop must be installed between the toilet and the Treatment Tank (see Fig. #2). If the treatment unit must be mounted more than a few inches higher than the toilet, contact Raritan Customer Service.

WARNING: DO NOT locate in an area where ambient temperature exceeds 120° F.

Securing Treatment Tank:

1. Make mounting frame (Fig. #5).
2. Secure mounting frame using suitable fasteners.
3. Use 3/4" mounting straps to secure tank to frame (see Fig. #5). A 3/8" rubber pad (available at a hardware store) placed under the tank will help to reduce vibration and noise.

Use high quality, smooth interior 1 1/2" I.D. sanitation hose to avoid odor problems, available from Raritan by the foot (part #SH). Discharge from the toilet enters either *side* of the Treatment Tank and exits from the fitting on *top* of the lid.

1. Connect Lectra/San EC to marine toilet per Figures #2, #3 or #4. Do not route hose into dips or valleys and avoid 90° fittings where possible.
2. Use teflon tape or nonpermanent thread sealing compound on threaded PVC fittings and connections.
3. Determine the orientation of the discharge elbow provided before gluing with PVC Cement.
4. Double clamp all hose fittings below the waterline.

Control Indicator Panel

1. Locate an area in the head compartment where the indicator lights will be readily visible.
2. Using template provided, mark the cutout for the panel. Do not cut outside of template markings.
3. Route ribbon cable between panel and Lectra/San EC Treatment Unit. Secure ribbon cable with cable holders every 18 inches, taking care not to puncture the insulation or crimp the cable.
4. Plug in the ribbon connection (Fig. #6) to indicator panel and mount panel using four #6 screws.

Salt Feed Tank: (Salt Feed Tank is needed when the boat will be in fresh water/brackish water.)

1. Assemble the salt feed tank per Fig. #7A.
2. Locate Salt Feed Tank within 6 feet of toilet and at same level as bowl. Secure tank. Make sure the tank is accessible for refilling.
3. Attach the T-check valve and tubing to the Salt Feed Tank.
4. Attach T-check valve in the intake line (suction) of the toilet. Remove the ball and spring in Raritan PHII models (Fig. #7).
5. In a separate container, combine five pounds of rock salt with two gallons of warm water and allow to dissolve overnight. Pour off water into tank (this is a saturated salt solution). The salt remaining in the bottom may be used the next time.

☞ Atlantes owners: Use deodorant tank for salt mixture, reduce concentrate ratio by 1/2.

ELECTRIC WIRING

WARNING: Danger of electric shock. Be sure to disconnect power.

1. Run supply wire to Positive and Negative terminals using specification table for wire size and circuit breaker.
2. Connect wires to Positive and Negative terminals on Treatment Tank (Fig. #8).
3. Connect ribbon cable, (#31-404) from Control Indicator Panel to the Control Module (Fig. #10). Secure strain relief.
4. If you wish to flush an electric toilet (other than the Atlantes) by pushing the Lectra/San EC Control Indicator Panel, a **Raritan Continuous Duty Solenoid** must be installed and wired per Fig. #9. (Atlantes see Fig. #9A.) **Failure to follow this correctly will result in damage to the Lectra/San EC control board and will void warranty.**

IMPORTANT: Check polarity before turning on power.

5. Follow start up procedure under Recommissioning and Start up.

WARNING: All control boards are pretested at the factory. Burnt control board components or foils are a result of improper wiring by the installer. Board replacement in these cases are not covered by Raritan's limited warranty.

Fig. #7A
SALT FEED TANK EXPLODED VIEW AND PARTS LIST:

1203B1	O-Ring	31-304A	Adapter Assembly
31-301	Salt Feed Tank	31-304C	Metering Thumbwheel
31-302	Salt Feed Tank Cap	31-305	1/4" Tubing

T-CHECK VALVE EXPLODED VIEW AND PARTS LIST:

1	Valve Body	31-307D
2	Siphon check valve	31-308W
3	Ball	CH12
4	Spring	CH8
5	O - Ring	31-307E
6	Discharge Adapter	31-307D1

Salt Feed Tank complete - 31-3001
T-Check Valve complete - 31-307W

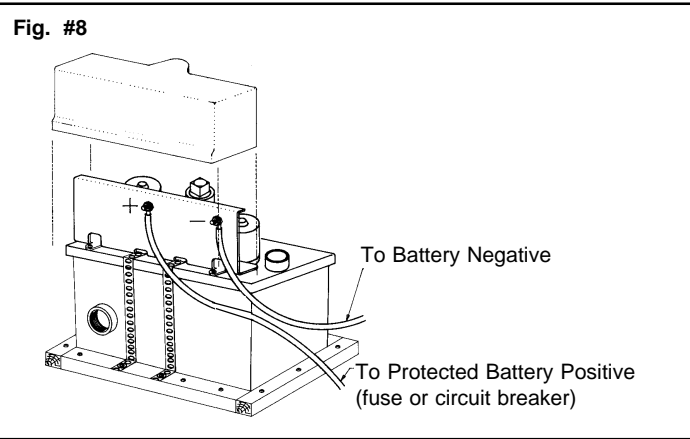

Lectra/San EC SPECIFICATION TABLE

ELECTRICAL:							
Voltage Nominal	12VDC	24VDC	32VDC	Max Amperage:	12VDC	24VDC	32VDC
Voltage Minimal	11.5V	22.0V	31.0V	Mixer Motor amp	5	4	4
Power	1.7 amp hr	1.5 amp hr.	1.5 amp hr.	"A" Fuse Type MDL	6 1/4	6 1/4	5
Current	50 A	42 A	35 A	Electrode Pack	25	22	22
Fuse/Breaker	60 A	50 A	50 A	"B" Fuse Type MDL	35	30	30
Length of circuit:	Wire Gauge			Solid Reduction Motor	20	16	9
0-15'	#6 AWG	#8AWG	#10AWG	"C" Fuse Type MDL	30	25	20
15'-25'	#4 AWG	#6AWG	#6AWG				
26'-50'	#1 AWG	#4AWG	#6AWG				

☞ **NOTES:**

1. Wire distance is determined by measuring from the battery to the Lectra/San and back again.
2. Minimal Voltage is read across the electrode pack while the system is operating in the treatment (2nd) cycle.
3. Requires ocean grade salinity for proper conductivity.

Gallons of Waste Treatable/Day: 576
Maximum Roll/Pitch Angle: 30°
Maximum Temperature Exposure: 120° F
Maximum Total Flush Volume: 1.5 Gallons/Flush

Fig. #9

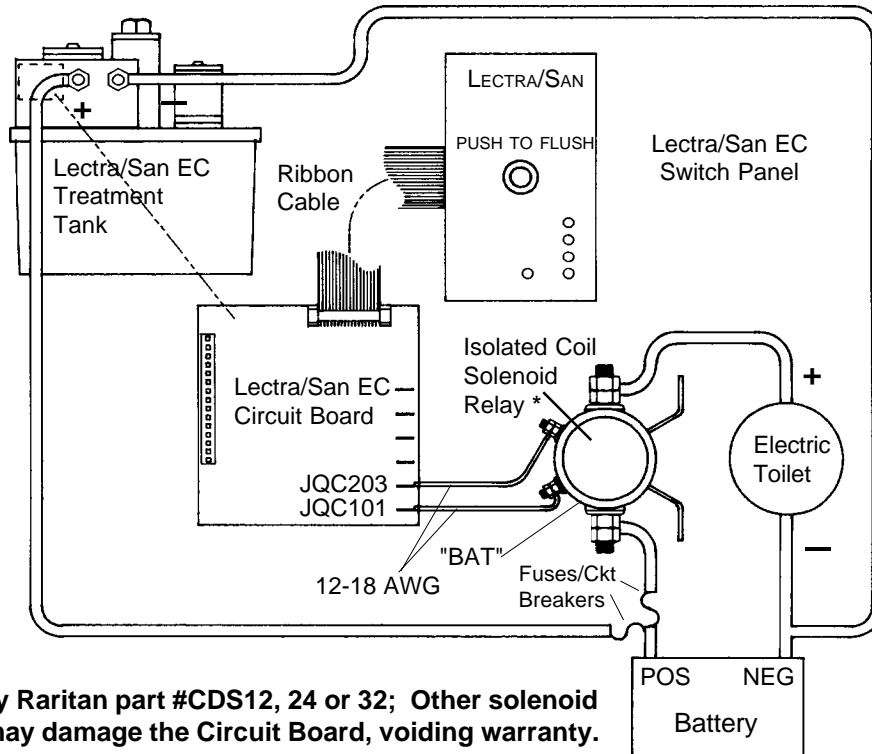

*** Use Only Raritan part #CDS12, 24 or 32; Other solenoid relays may damage the Circuit Board, voiding warranty.**

Fig. #9A

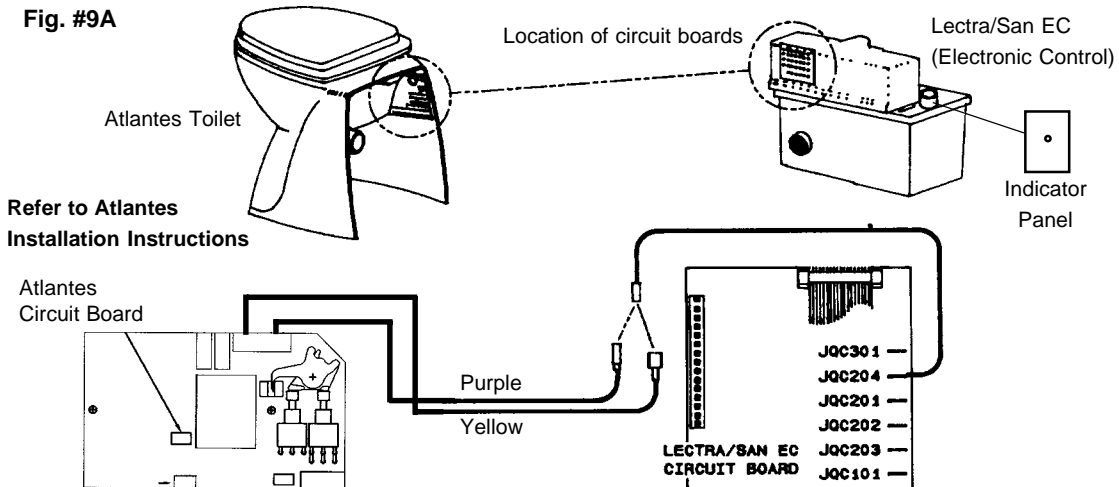

Refer to Atlantes Installation Instructions

Fig. #10

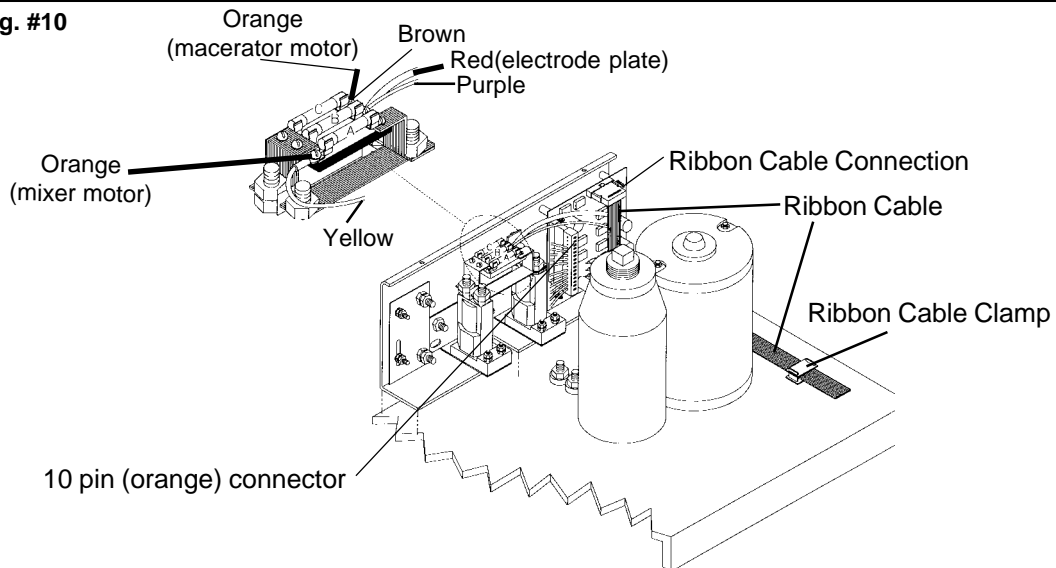

TROUBLESHOOTING

PROBLEM	POSSIBLE CAUSE	CORRECTION
A. When button is pushed, nothing happens; system inoperative.	A1. No power to unit. A2. Open or loose connection. A3. Damage to Control Board. A4. Inoperative switch panel assembly. A5. Damage to ribbon cable.	A1. Check circuit breaker or main fuse to unit. Check connections to Positive and Negative terminal. A2. Check and clean connectors by disconnecting and reconnecting. A3. Replace Control Board. A4. Replace switch panel assembly. A5. Replace ribbon cable.
B. "Check Fuse" light is on.	B1. Fuse blown. B2. Low voltage at Treatment Unit. B3. Damage to control board.	B1. Check fuse A, B or C on Treatment Unit. B2. Check voltage at Treatment Unit and at battery during Treatment Cycle. See Specification Table for minimum voltage. B3. Replace board.
C. Low salt light on. The low salt indicator is lit when the electronics in the Lectra/San EC control board determines that not enough current is flowing through the electrodes. This can be caused by any combination of C1 - C4 or all of them.	C1. Low salt. C2. Dirty electrode plates. C3. Low voltage at Treatment Unit. C4. Water too cold.	C1. Add salt to system. C2. Clean electrode plates (see maintenance). C3. Check voltage at Treatment Unit and at battery during Treatment Cycle. See Specification Table for minimum voltage and wire size. C4. Increase salt tank flow. Contact Raritan Customer Service.
D. High salt light on.	D1. Too much salt.	D1. Reduce salt concentration; add fresh water to toilet bowl.
E. Inconsistent operation (check fuse light or incomplete cycling).	E1. Drop in line voltage. E2. Other equipment operating on same electric circuit as Lectra/San EC.	E1. Check voltage at Treatment Unit and battery during Treatment Cycle. See Specification Table for minimum voltage and wire size. E2. Isolate circuit.
F. Sewage odor.	F1. Odor permeating through discharge hose. F2. Treatment Unit has leak. F3. System not stored properly. F4. Lectra/San not being activated consistently. F5. Damage to electrode plates; Plates not drawing enough current. F6. B-Fuse blown - electrodes not being activated.	F1. Rub cloth on outside of hose. If odor transfers to cloth; all discharge hose must be replaced with high quality discharge hose (Raritan #SH). F2. Check for liquid leaks (not gas). Follow discharge hose from toilet to Treatment Tank until leak is located and corrected. F3. See Page 3 (STORAGE). F4. System designed to treat each flush - the unit must be activated at each flush. F5. Clean dirty electrode plates or replace. F6. Replace the B-Fuse. Test the electrodes. Replace if necessary.

If above troubleshooting does not solve the problem, contact your dealer or Customer Service at Raritan.

Item	Part No.	Description
1	32-102**	Mixer Motor 2 1/2" Dia. 12 VDC
1	33-102**	Mixer Motor 2 1/2" Dia. 24 VDC
1	34-102**	Mixer Motoer 2 1/2" Dia. 32 VDC
2	31-121	Hose Fitting
3	31-120	Discharge Elbow 90
4	M30	Electrode Lug Nut, 1/4"-20 Brass (4)
5	M31	Electrode Flat Washer, 1/4", Brass (4)
6	31-113-1	Cover Hold Down Bolt, 10-32x3/4" (16)
7	31-103	Motor Shaft Bushing (2)
8	31-106	Motor Hold Down Bolt, 10-32x7/8", S/S(6) (Hold down bolts must be completely covered with silicone caulk before final reassembly to prevent leaking.)
9	31-109	Mixer Impeller
10	31-110-1	Impeller Bolt, 12-24x5/8", S/S (2)
11	31-110-2	Impeller Lock Washer, #12, S/S (2)
12	31-114	Cover Hold Down Nut, 10-32 (18)
13	31-115	Treatment Tank
14	31-122	Intake Plug
15	32-5000	Electrode Pack 12 VDC
15	33-5000	Electrode Pack 24 VDC
15	34-5000	Electrode Pack 32 VDC
16	31-112	Cover Gasket
17	31-108	Macerator Set Screw, 8-32x3/16", S/S
18	31-107	Macerator Impeller
19	31-101W	Treatment Cover (Inc. items 7, 20 and 21)
20	31-104	Crossover Plug
21	31-102	Motor Shaft Seal (2)
22	32-101**	Macerator Motor 3" Dia. 12 VDC
22	33-101**	Macerator Motor 3" Dia. 24 VDC
22	34-101**	Macerator Motor 3" Dia. 32 VDC
	31-3001	Salt tank assembly (not shown)
	32-4000*	12 V DC Complete Treatment Unit (Items 1-22)
	33-4000*	24 V DC Complete Treatment Unit (Items 1-22)
	34-4000*	32 V DC Complete Treatment Unit (Items 1-22)

* Less Control Box Assembly

**NOTE: When replacing existing or new motor(s), apply silicone caulk over motor - hold down bolt heads. Dispense enough sealant to cover an area three times greater than the bolt heads to avoid leaking through bolt holes.

EXPLODED PARTS VIEW OF COMPLETE TREATMENT UNIT

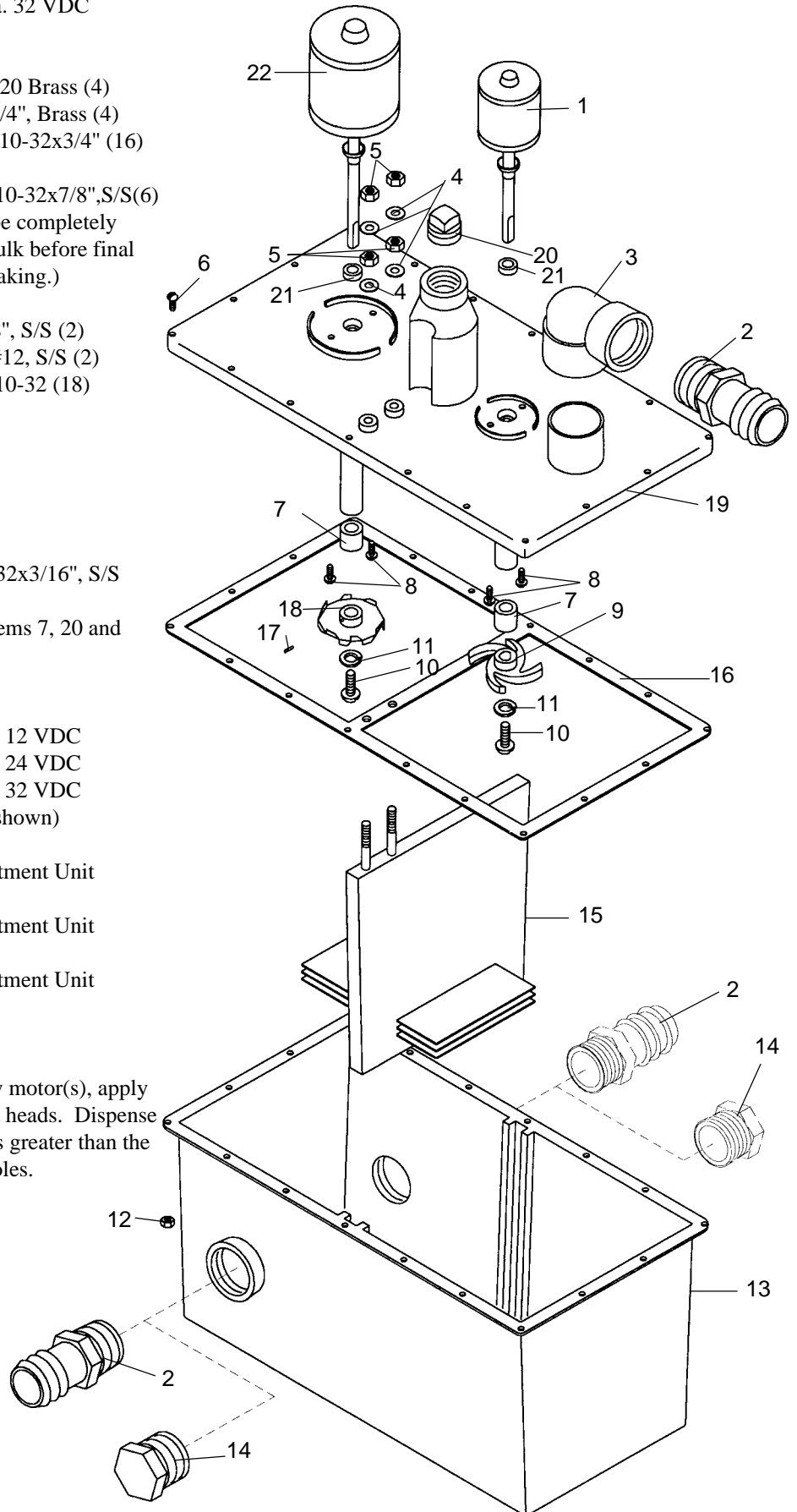

EXPLODED PARTS VIEW OF CONTROL MODULE

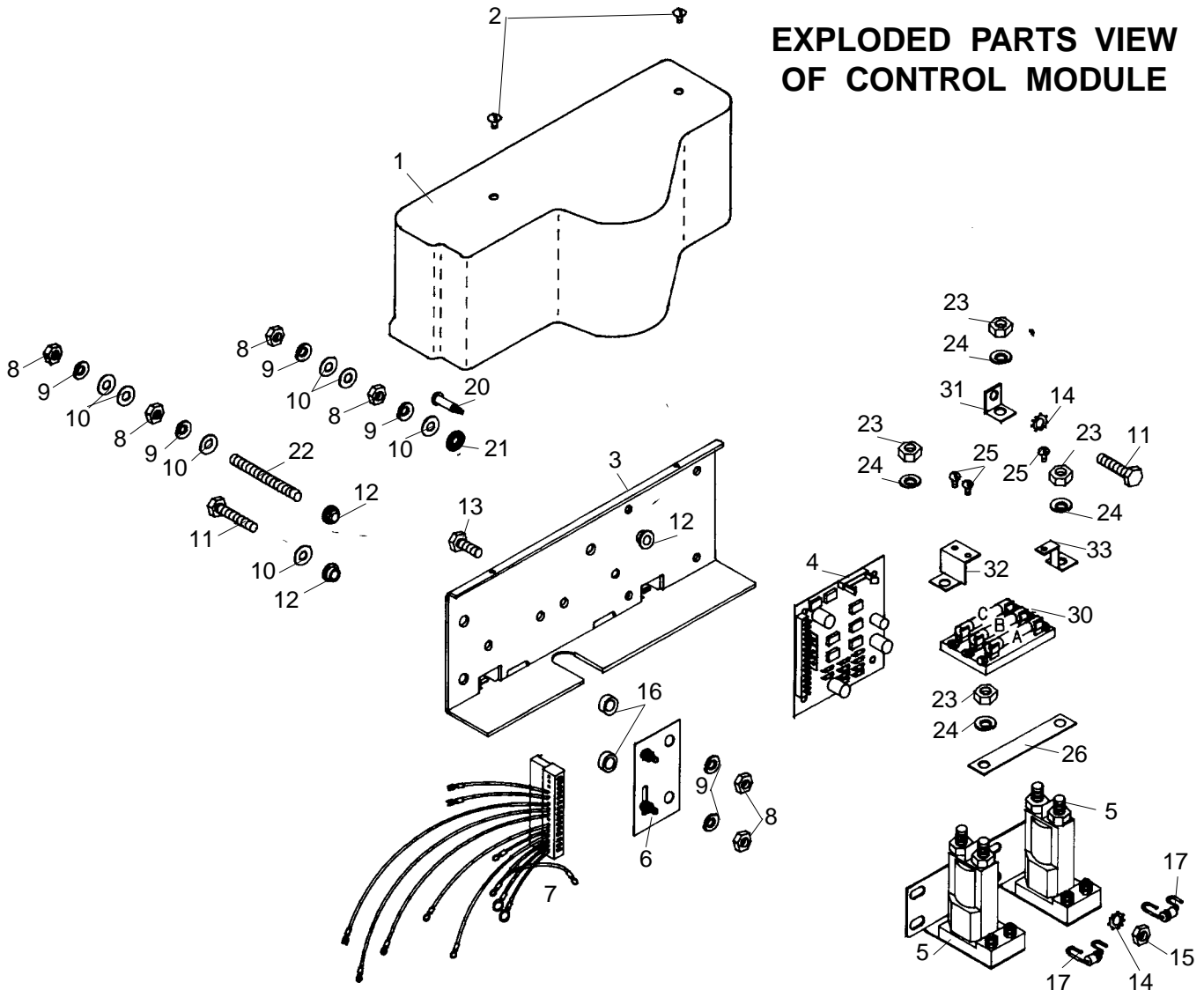

Item	Part No.	Description	Item	Part No.	Description
1	31-460	Control Cover	21	F069	Gray Fiber Flat Washer
2	CH26	8-32 x 7/16" Truss head screw (2)	22	F31-478	Threaded Rod 1/4 - 20 x 2" Brass
3	31-462	Mounting Plate	23		5/16 - 24 Nut (4)
4	32-401	Control Board Assy. - 12V	24		5/16 Lockwasher (4)
	33-401	Control Board Assy. - 24V	25		#6-32 Screw
	34-401	Control Board Assy. - 32V	26	31-464	Bracket
5	AM06012	Solenoid Relay (2) - 12V	30	31-232	Fuse Block
	AM06024	Solenoid Relay (2) - 24V	30A	32-218	MDL 6 1/4 Fuse
	AM06032	Solenoid Relay (2) - 32V	30B	32-219	MDL 35 Fuse
6	RBS50	Shunt Assy.	30C	32-220	MDL 30 Fuse
7	31-402A	Wiring Harness Assy.	31	31-466	Bracket
8	M30	1/4 - 20 Brass Nut (6)	32	31-468	Bracket
9	HLWQB	1/4" Lockwasher (6)	33	31-470	Cond. Bracket
10	M31	#14 Brass Flat Washer (7)		32-402	12V Control Box Assy. (incl. all above parts except 1 and 2)
11	HSB1	1/4 - 20 Brass Cap Screw (2)		33-402	24V Control Box Assy. (incl. all above parts except 1 and 2)
12	RNI	Nylon Shoulder Washer (3)		34-402	32V Control Box Assy. (incl. all above parts except 1 and 2)
13	1119A	1/4 - 20 x 1/2" S/S Hex Head Machine Screw (4)		31-403	Indicator panel assembly (not shown)
14	1118	1/4" External Tooth Washer (5)		31-404	Ribbon cable (not shown)
15	1226B	1/4 - 20 S/S Hex Head Nut (4)			
16	31-476	Nylon Spacer Washer (2)			
17	ED1N4002	Diode (2)			
20	F31-480	Nylon Stand Offs: PCB Supports (4)			

NOTE: ALL PART #'S BASED ON A 12V SYSTEM, ALL OTHER PART #'s, CONTACT RARITAN

() Indicates Total pieces required

USING THE LECTRA/SAN EC SYSTEM WITH TWO MARINE HEADS

NOTE: Single push button operation of LST/EC or toilet cannot be installed in this application.

The Lectra/San EC Type I MSD can be connected to two marine toilets. However, the two toilets must be in close proximity to:

1. Reduce the pressure requirement to move waste through the connecting hose.
2. To decrease the possibility of untreated sewage remaining in the lines.

The Lectra/San EC Treatment Tank should be located midway between the two toilets. **The maximum distance from either toilet to the tank should not exceed six feet.**

A kit is available for field conversion to dual toilet operation:

Lectra/San EC Dual Control Component part #LSTEDC (for 12 V units):

1. Control Indicator Panel with ribbon cable attached.
2. Salt Feed Tank complete.

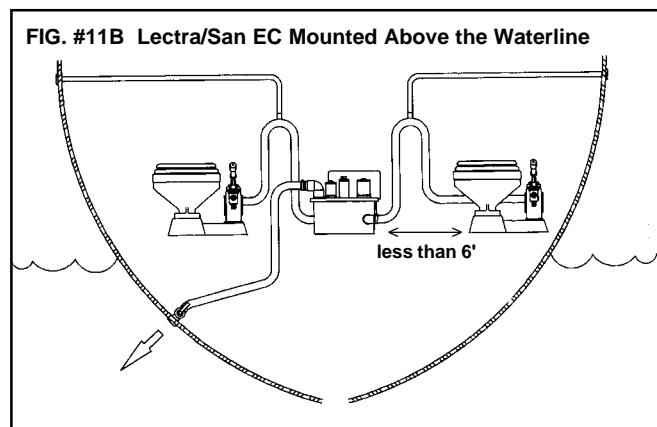
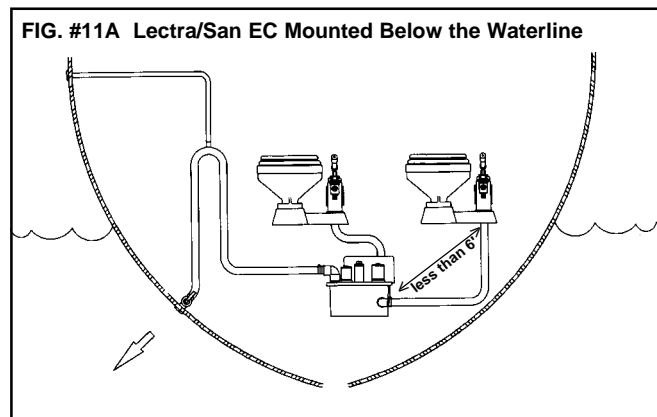

INSTALLATION

1. **Adding second toilet** - Install Lectra/San and first toilet per manual, then add second toilet by connecting discharge line to the opposite side of the tank. Remove the plug to allow connections. (See Figures #11A and #11B)
2. **Electric toilet** - Installations with two electric toilets must be wired to work independent from the Control Indicator Panels. Contact Raritan Customer Service for instructions.
3. **Mounting** - Each toilet should be installed within six feet of Lectra/San EC.
4. **Control Indicator Panel** - The Dual Control Indicator Panel attaches directly to the Lectra/San EC circuit board, the original Control Indicator Panel connects inline using the special connector attached to the dual control ribbon (See Fig. #12A).

OPERATION

Indicator/LED lights will indicate operation on both panels when any toilet is in use. DO NOT activate "Push to Flush" button if another toilet is in use.

A Salt Feed Tank should be installed in each toilet's intake hose if operating in fresh or brackish water. The flow control for each Salt Feed Tank must be set independently.

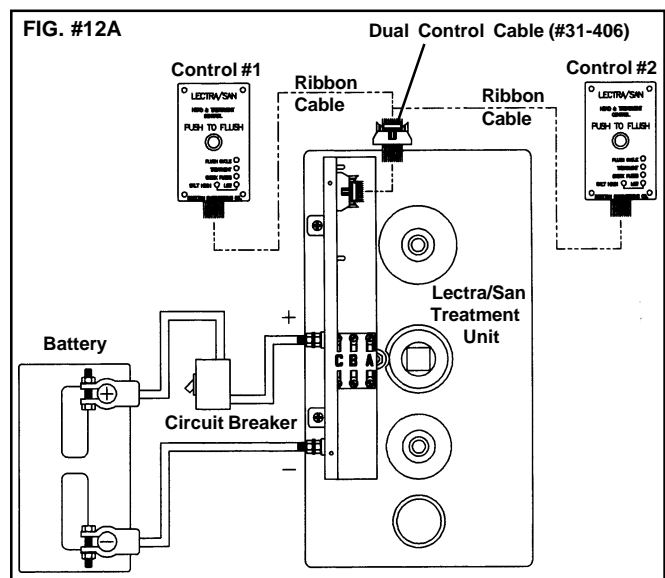

CONVERSION OF LECTRA/SAN TO LECTRA/SAN EC INSTALLATION INSTRUCTIONS

Parts included in package:

Control Module (32-402, 33-402 or 34-402) - Mounts directly to treatment unit

Control Cover (31-460) - Installs over Control Module

Control Indicator Panel (31-403) - Replaces old Control unit

Ribbon Cable (31-404) - Connects Control Module To Control Indicator Panel - 12' long.

Tools needed - 3/8", 5/16", and 7/16" nut drivers, blade and Phillips head screw drivers, wire cutters, #14 AWG strippers and crimpers and small adjustable wrench.

INSTALLATION

Before beginning conversion disconnect battery leads and be sure power to unit is OFF.

If old control unit was flush mounted you will need to cover the opening. If the new control indicator panel will be located in the same opening see the panel template for cutout purposes.

A. Existing Control Unit - Remove and discard existing Control Unit (32-2000, 33-2000 or 34-2000) and Control Cable (31-210), reroute positive (+) wire from terminal E on the relay to the Treatment Tank. Connection will be made during Step 9.

B. Treatment Tank

1. Remove terminal block (31-131), save screws, nuts and washers for mounting Control Module in Step 5. Discard terminal block (see Fig. #11C). Disconnect negative battery wire to electrode pack.
2. Remove mounting straps. They will need to be routed through the slots on new Control Module (Fig. #12B).
3. Remove two screws from lid as shown in Fig. #12B and reinstall them in place of the screws removed in Step 1. The two holes left by removing the screws will be used for attaching the Control Module in Step 5.

4. Connect RED (+) and BLACK (-) wires from new Control Module to POSITIVE (+) and NEGATIVE (-) lugs on cover (Electrode Pack). Polarity must be the same (see Fig. #13B).
5. Mount Control Module (32-402, 33-402 or 34-402) using the screws from Step 1.
6. Cut the BLACK NEGATIVE (-) wire terminals off both the mixer and macerator motors. Strip 3/8" of wire and attach to crimp connectors on the black leads from Control Module (see Fig. #13B).
7. Cut the POSITIVE (+) wire terminal off the macerator (larger) motor and strip 3/8" of wire. Attach to ORANGE POSITIVE (+) lead with crimp connector from fuse block (see Fig. #13B).
8. Connect mixer (smaller) motor POSITIVE (+) lead to Fuse A on fuse block using the existing terminal (see Fig. #13B).
9. Connect POSITIVE (+) and NEGATIVE (-) wires to the front side of Control Module (see Fig. #12B).
10. Reinstall mounting straps through slots on Control Module and resecure them (Fig. #12B).

Control Indicator Panel - See mounting and electric wiring section.

Install Cover on Control Module

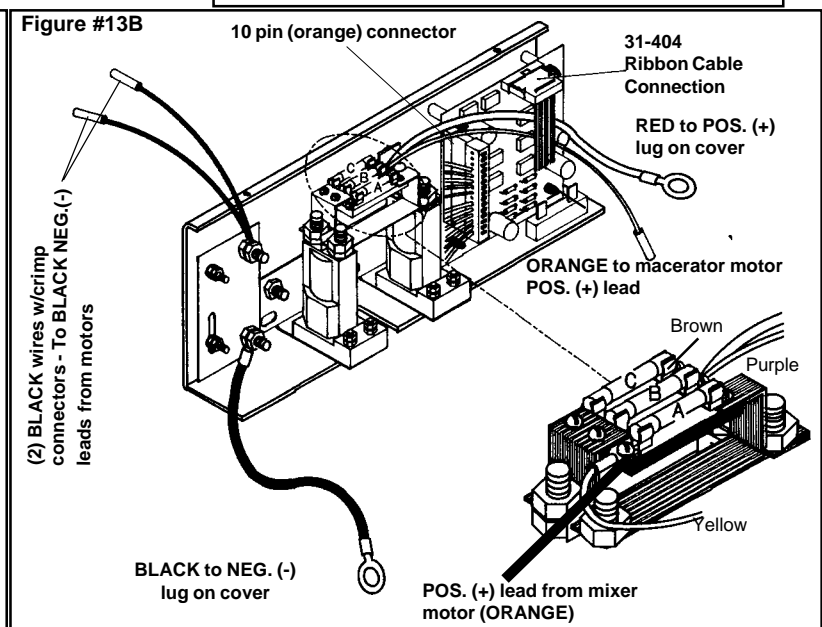
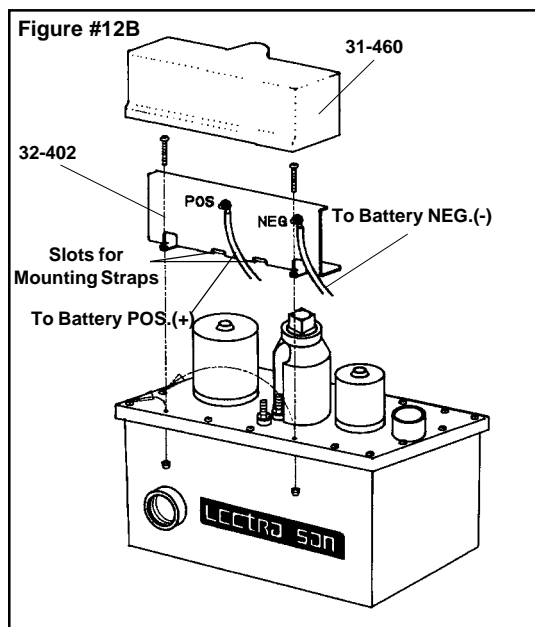
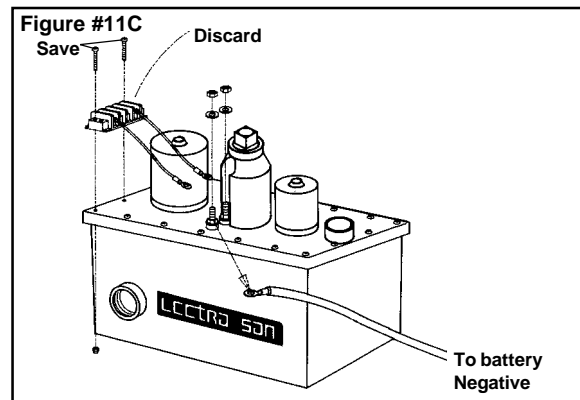

**CONTROL INDICATOR
PANEL TEMPLATE**

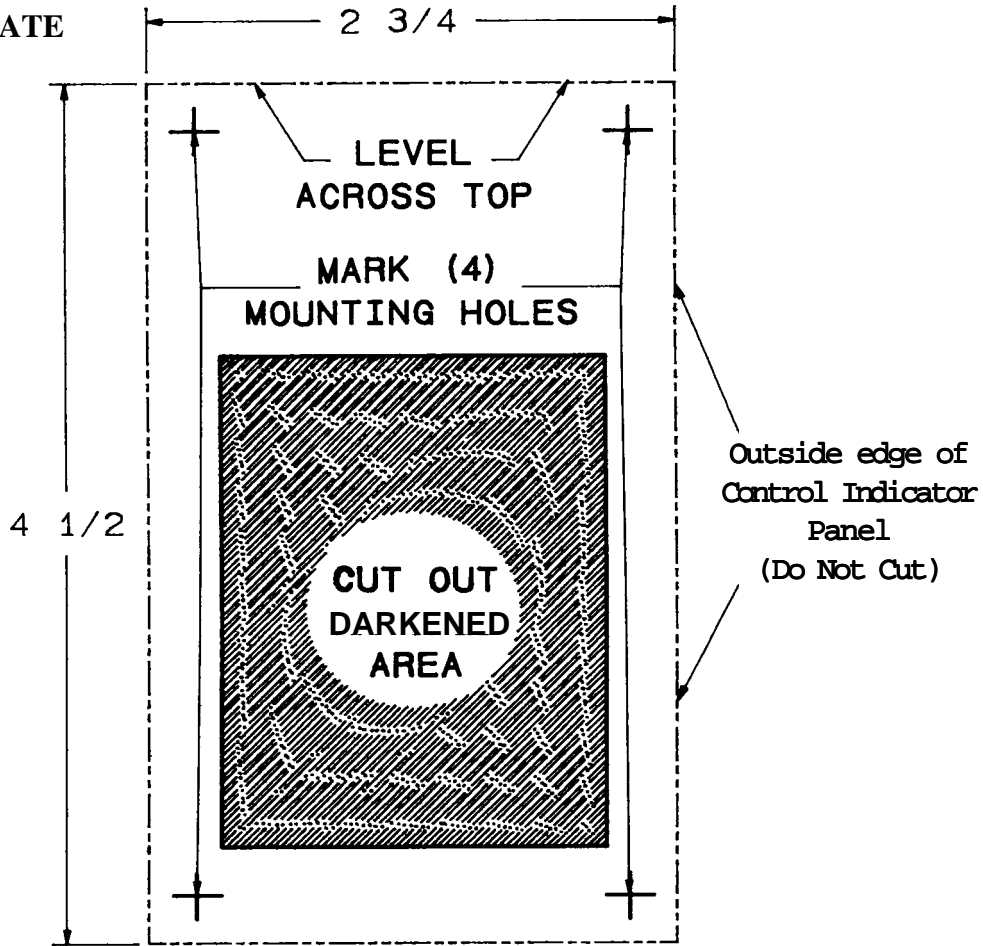

LIMITED WARRANTY

Raritan Engineering Company warrants to the original purchaser that this product is free of defects in materials or workmanship for a period of one year from the product's date of purchase. Should this product prove defective by reason of improper workmanship and/or materials within the warranty period, Raritan shall, at its sole option, repair or replace the product.

1. TO OBTAIN WARRANTY SERVICE, Consumer must deliver the product prepaid, together with a detailed description of the problem, to Raritan at 530 Orange St., Millville, N.J. 08332, or 3101 SW 2nd Ave. Ft. Lauderdale, FL 33315. When requesting warranty service, purchaser must present a sales slip or other document which establishes proof of purchase. THE RETURN OF THE OWNER REGISTRATION CARD IS NOT A CONDITION PRECEDENT OF WARRANTY COVERAGE. However, please complete and return the owner Registration Card so that Raritan can contact you should a question of safety arise which could affect you.
2. THIS WARRANTY DOES NOT COVER defects caused by modifications, alterations, repairs or service of this product by anyone other than Raritan; defects in materials or workmanship supplied by others in the process of installation of this product; defects caused by installation of this product other than in accordance with the manufacturer's recommended installation instructions or standard industry procedures; physical abuse to, or misuse of, this product. This warranty also does not cover damages to equipment caused by fire, flood, external water, excessive corrosion or Act of God.
3. ANY EXPRESS WARRANTY NOT PROVIDED HEREIN, AND ANY REMEDY FOR BREACH OF CONTRACT WHICH BUT FOR THIS PROVISION MIGHT ARISE BY IMPLICATION OR OPERATION OF LAW, IS HEREBY EXCLUDED AND DISCLAIMED. ALL IMPLIED WARRANTIES SUCH AS THOSE OF MERCHANTABILITY AND OF FITNESS FOR A PARTICULAR PURPOSE, IF APPLICABLE, AS WELL AS ANY IMPLIED WARRANTIES WHICH MIGHT ARISE BY IMPLICATION OF LAW, ARE EXPRESSLY LIMITED TO A TERM OF ONE YEAR. SOME STATES DO NOT ALLOW LIMITATIONS ON HOW LONG A LIMITED WARRANTY LASTS, SO THE ABOVE LIMITATION MAY NOT APPLY TO YOU.
4. UNDER NO CIRCUMSTANCES SHALL RARITAN BE LIABLE TO PURCHASER OR ANY OTHER PERSONS FOR ANY SPECIAL OR CONSEQUENTIAL DAMAGES, WHETHER ARISING OUT OF BREACH OF WARRANTY, BREACH OF CONTRACT, OR OTHERWISE. SOME STATES DO NOT ALLOW THE EXCLUSION OR LIMITATION OF INCIDENTAL OR CONSEQUENTIAL DAMAGES, SO THE ABOVE LIMITATION OR EXCLUSION MAY NOT APPLY TO YOU.
5. No other person or entity is authorized to make any express warranty, promise or affirmation of fact or to assume any other liability on behalf of Raritan in connection with its products except as specifically set forth in this warranty.
6. This warranty gives you specific legal rights, and you may also have other rights which vary from state to state.

	<p>RARITAN Engineering Company, Inc.</p>	<p>530 Orange Street, P.O. Box 1157, Millville, NJ 08332 USA Telephone: 609-825-4900 FAX: 609-825-4409 www.raritaneng.com Southern Office and Plant: 3101 SW Second Avenue, Fort Lauderdale, FL 33315 USA Telephone: 954-525-0378 FAX: 954-764-4370</p>
---	---	--