

SeaEra™

FLOOR TEMPLATE

MODELS: 160HI0 and 160MI0****

(**): VOLTAGE 12, 24 or 32)

⚠ IMPORTANT:

INSTRUCTIONS FOR PRINTING AND ASSEMBLING TEMPLATE.

1. Template is PDF format, for 8 1/2 x 11" paper.
2. Page Scaling: Select 'NONE' (MUST PRINT FULL SCALE)
3. With scissors, cut on 'Dashed Lines'.  - - - - -
4. Align sheets accordingly using Dashed Lines and corresponding Alignment Arrows and tape together.
5. Check that printed template is the correct scale (size) by measuring at the CHECK POINT on template (lower left). You should measure 7" (178mm).

⚠ IMPORTANT:

1. DO NOT DRILL OR CUT HOLES FROM THIS TEMPLATE. FOR REFERENCE ONLY,
2. REFER TO INSTALLATION MANUAL FOR INSTALLATION DETAILS.
3. CHINA BOWL DIMENSIONS CAN VARY +/-5%. CONSIDER THIS WHEN INSTALLING.
4. DIMENSIONS ARE: INCHES [MM]

SHEET 1	1	SHEET 2	3
SHEET 3	4	SHEET 4	6
SHEET 5	7	SHEET 6	

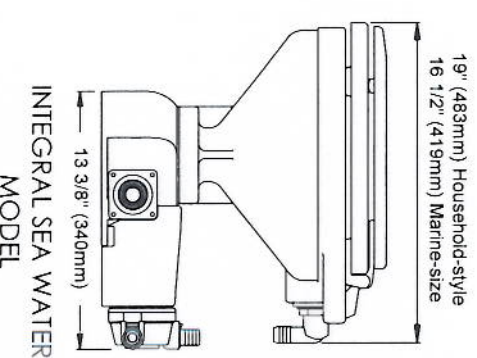
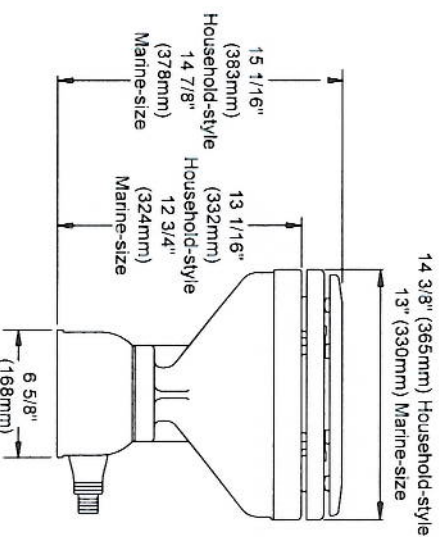

WWW.RARITANENG.COM

SeaEra™

MODELS: 160HI0** AND 160MI0**

** VOLTAGE 12, 24 or 32

1 SHEET
THIS TEMPLATE SHOWS THE
LOWER BASE ASSEMBLY IN
THE STANDARD POSITION
AND ROTATED 90 DEGREES.

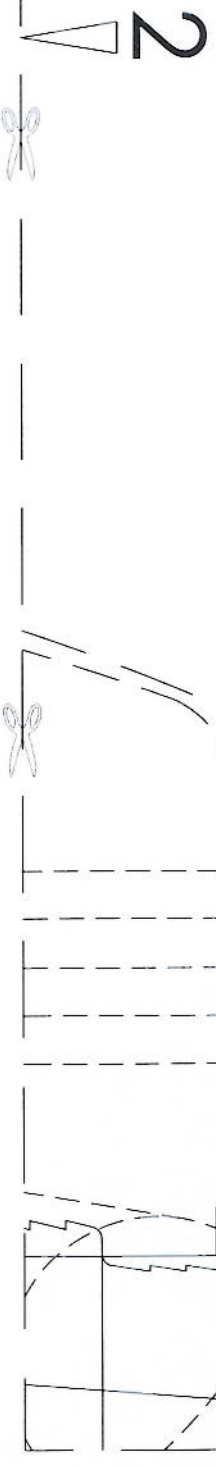

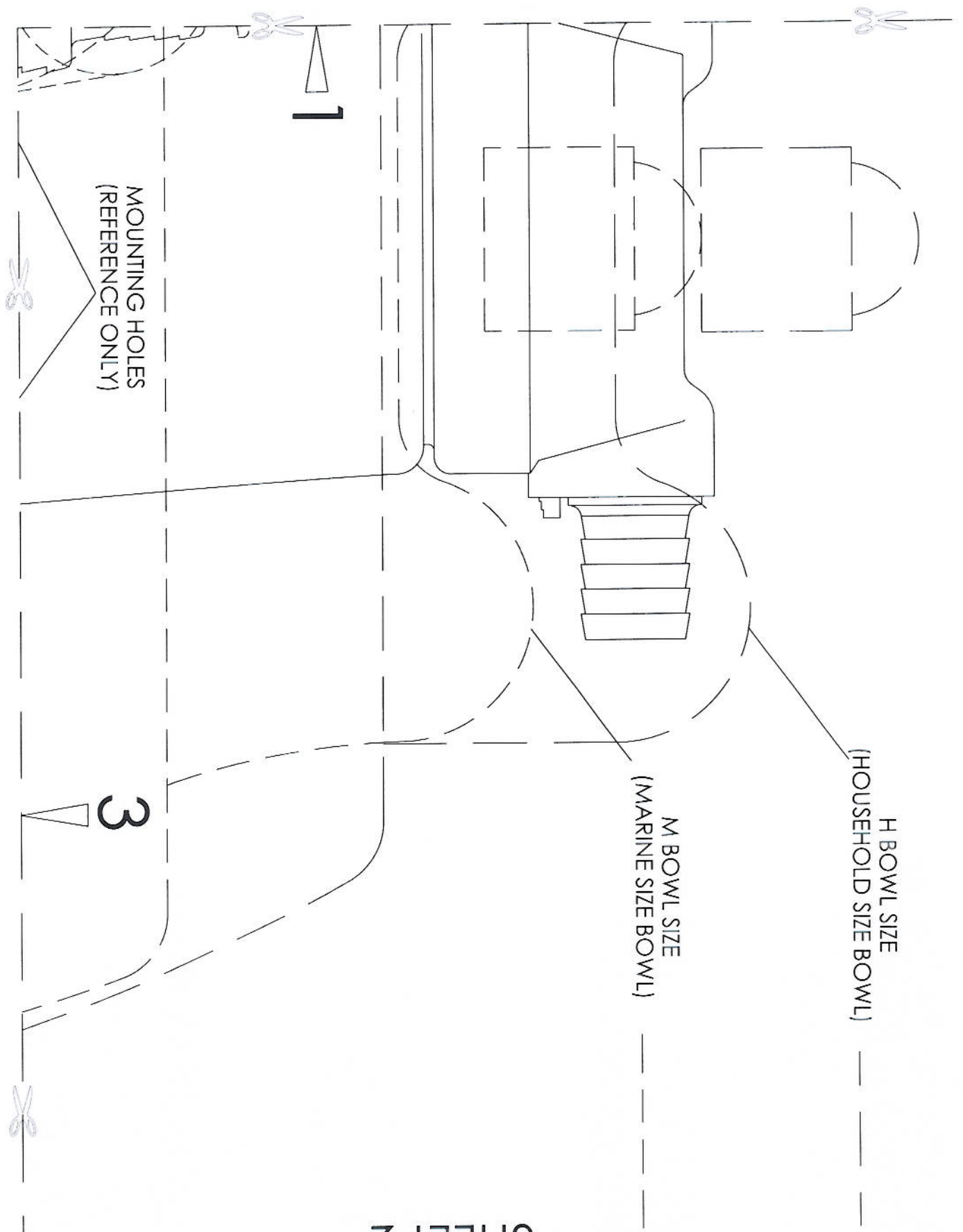

H BOWL SIZE
(HOUSEHOLD SIZE BOWL)

M BOWL SIZE
(MARINE SIZE BOWL)

MOUNTING HOLES
(REFERENCE ONLY)

SHEET 2

SHEET 3

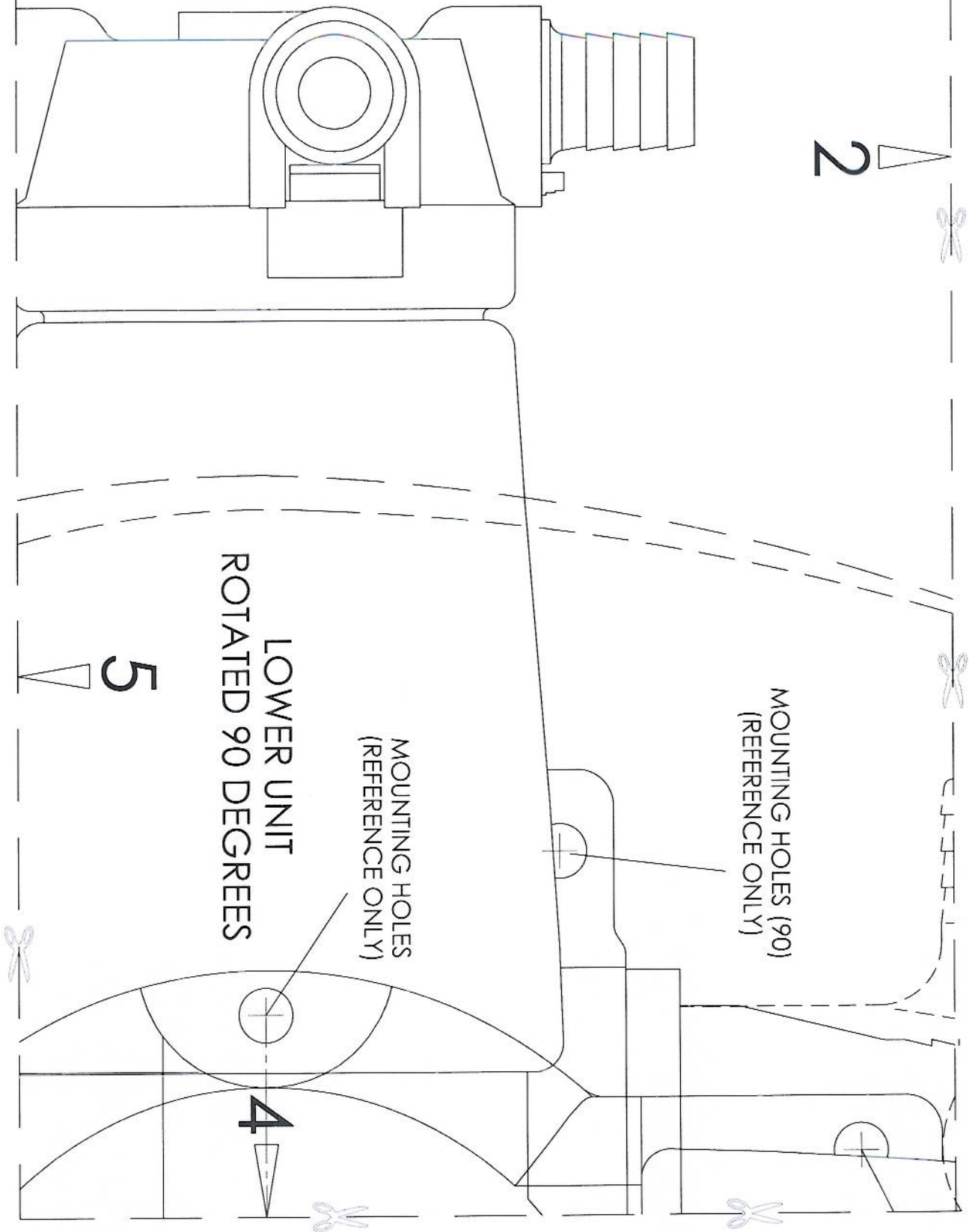

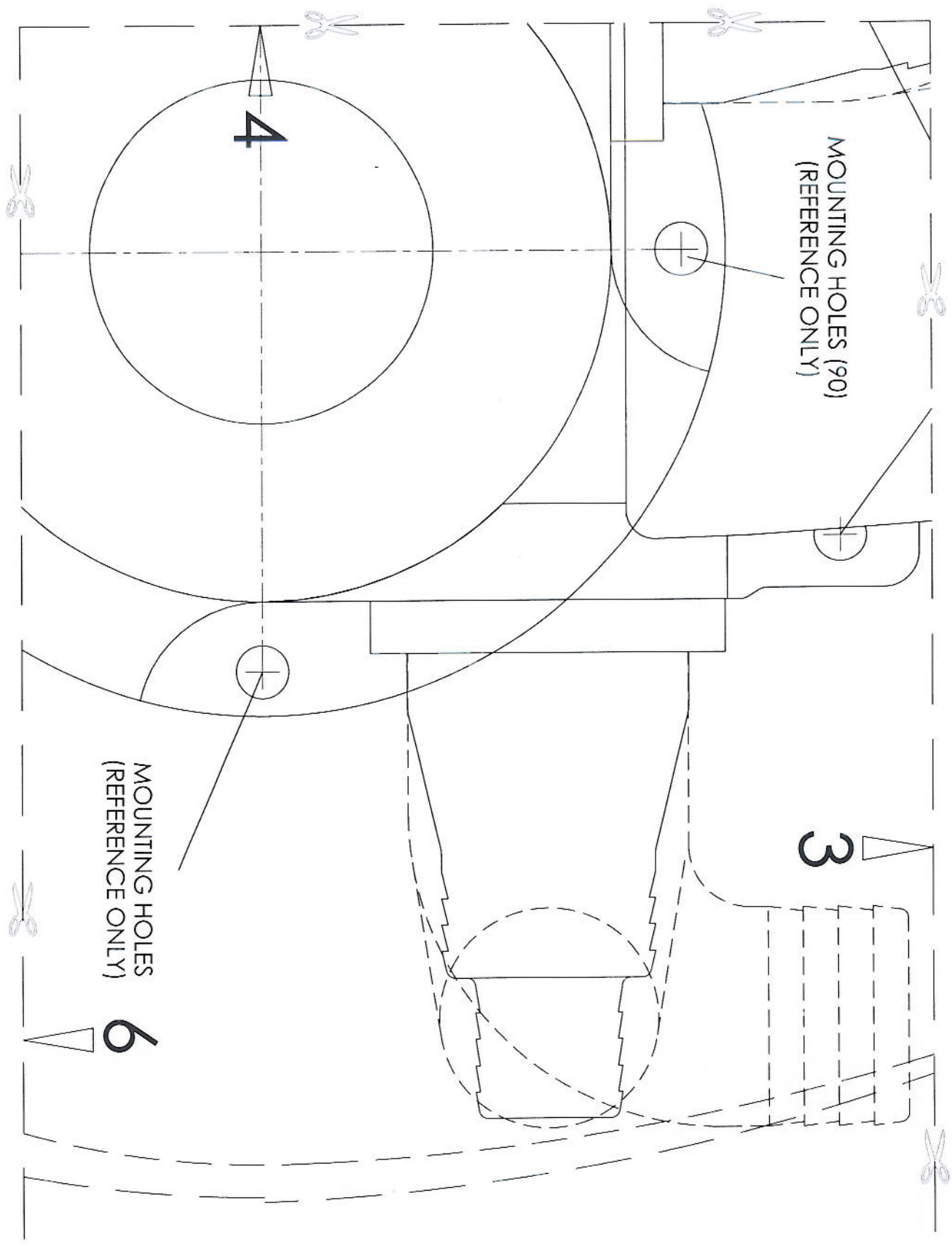

SHEET 4

SHEET 5

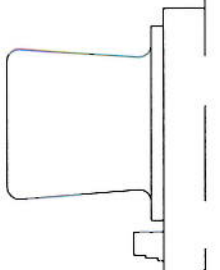

CHECK POINT

7
[178]

5

MOUNTING HOLES (90)
(REFERENCE ONLY)

7

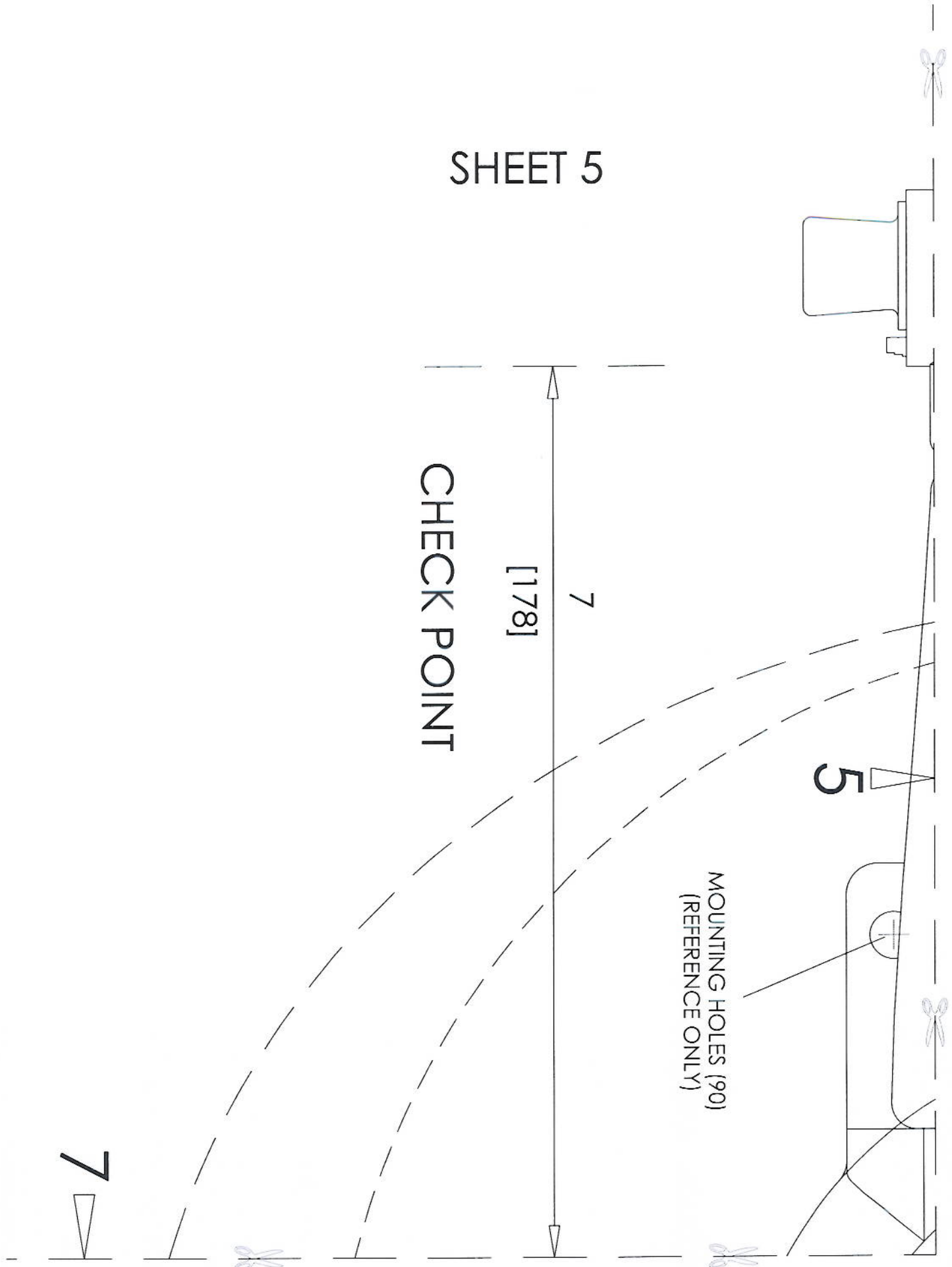



MOUNTING HOLES (90)
(REFERENCE ONLY)

6

SHEET 6

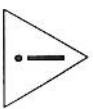

IMPORTANT:

1. DO NOT DRILL OR CUT HOLES FROM THIS TEMPLATE. FOR REFERENCE ONLY,
2. REFER TO INSTALLATION MANUAL FOR INSTALLATION DETAILS.
3. CHINA BOWL DIMENSIONS CAN VARY +/-5%. CONSIDER THIS WHEN INSTALLING.
4. DIMENSIONS ARE: INCHES [MM]